



Main Features

- Ranges: from 0...0.05 bar to 0...60 bar (0...1 to 0...1000 psi)
- Complete range of voltage/current outputs
- Protection rating: IP65/IP67
- Wetted parts: AISI304 , AISI316, NBR, Viton
- Operating temperature range -20...+85°C
- Accuracy: $\pm 0.15\%$ FSO typical
- Fill Fluid: silicone oil
- Available absolute ranges
- Available "Barometric" range (0.8-1.2 bar abs)
- Available low ranges (50mbar and 100mbar)

Series TSA transmitters are based on silicon piezoresistive sensing element in wheatstone bridge configuration.

Thanks to highly stable electronic components, these transmitters can be used in applications requiring long-distance signal transmission or in smart control systems.

TSA pressure transmitters were developed mainly for pressure measurement in industrial refrigeration and air conditioning, compressor and pumps. They are also used for monitoring and control on automatic machines and general purpose industrial applications.

TECHNICAL DATA

	VOLTAGE	CURRENT
Output signal	$\pm 0.15\%$ FSO typical; $\pm 0.2\%$ FSO max (gauge ranges)	
Accuracy (1)	$\pm 0.15\%$ FSO typical; $\pm 0.25\%$ FSO max (absolute ranges)	
Resolution	Infinite	
Overpressure (without degrading performance) (2)	see table	
Pressure containment (Burst test) (3)	see table	
Pressure media	Fluid compatible with AISI 316 Stainless steel, AISI 304, NBR, Viton	
Body materials	AISI 304 Stainless steel and Nylon 66GF35V0	
Power supply	15...30Vdc	10...30Vdc
Supply sensitivity	< 0.0015% FSO/V	
Insulation resistance	> 1000 M Ω @ 50Vdc	
Zero output signal	B, C, M, N, P, Q, R	4mA (E)
Full scale output signal	B, C, M, N, P, Q, R	20mA (E)
Max current absorption	< 13mA	< 32mA
Max allowed load	1mA	See diagram
Long term stability	< 0.1% FSO/per year (ranges ≥ 250 mbar)	
Operating temperature range (process)	-20...+85°C (-4...+185°F)	
Compensated temperature range	-10...+85°C (+14...+185°F)	
Storage temperature range	-30...+90°C (-22...+194°F)	
Temperature effects over compensated range (zero-span)	$\pm 0.01\%$ FSO/°C typical ($\pm 0.02\%$ FSO/°C max.) ranges >1 bar $\pm 0.04\%$ FSO/°C typical ranges ≤ 1 bar	
Response time (10...90%FSO)	< 1 msec.	
Start-up time	< 500 msec.	
Mounting position effects	Negligible (ranges ≥ 1 bar)	
Humidity	Up to 100%RH non condensing	
Weight	110 gr. nominal	
Mechanical shock	100 g / 1 msec. according to IEC 68-2-6	
Vibrations	20 g max @ 15-2000Hz according to IEC68-2-6	
Ingress protection	IP65/IP66/IP67	
Output short circuit and reverse polarity protection	YES	
Voltage spike protection	> 2kV burst test, to EN61000-4-4	
CE conformity (89/336 Directive)	EMC Emissions EN61000-6-3 EMC Immunity EN61000-6-2 (10V/m)	

FSO = Full Scale Output 1 BFSL method (Best Fit Straight Line); includes combined effects of Non-Linearity, Hysteresis and Repeatability
2 tested for more than 1000 strokes with single duration < 2msec. 3 tested for more than 100 strokes with single duration < 2msec.

MEASUREMENT RANGE (Bar)	0.05	0.1	0.25	0.5	1	0.8-1.2	2	2.5	4	5	6	7	10	16	20	25	30	40	50	60
Overpressure	3	3	2	4	5	3	10	12,5	20	20	35	35	40	80	80	90	90	90	90	90
Burst test	10	10	2,5	5	10	10	20	25	40	50	50	70	100	120	120	120	120	120	120	120

Absolute ranges ≥ 2 bar: overpressure 3xFS; burst test > 200bar

INSTALLATION DRAWINGS

Dimensions: mm [inches]

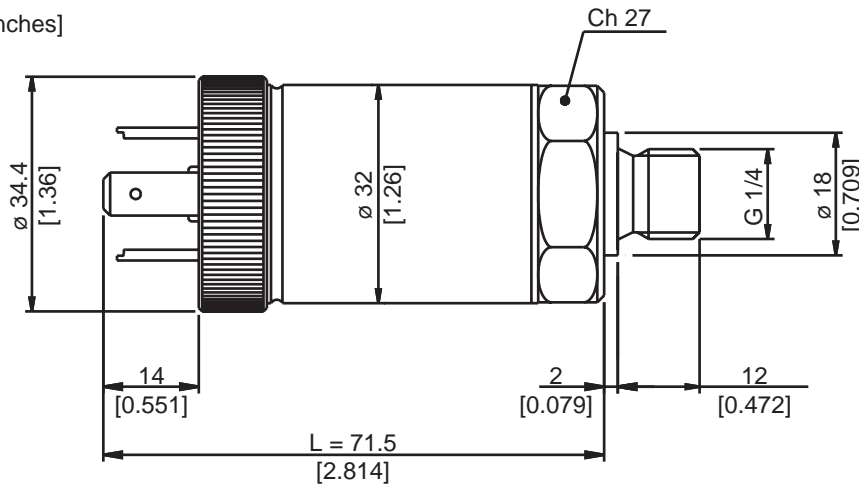

PRESSURE CONNECTION

(1) G 1/4 MALE (DIN 3852-A)

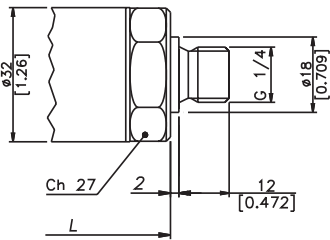

(2) SAE 04 AS4395 - E

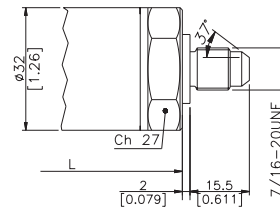

(3) G 1/2 A (DIN 16288)

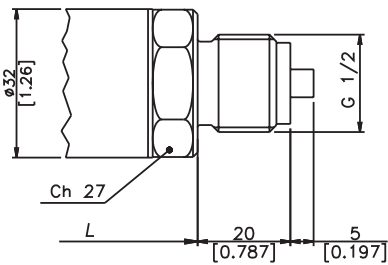

(4) G 1/4 FEMALE

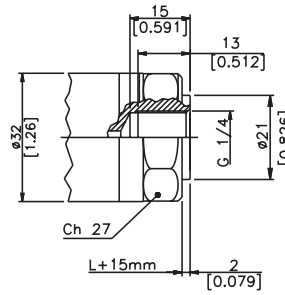

ELECTRICAL CONNECTION

P - 7 pole connector

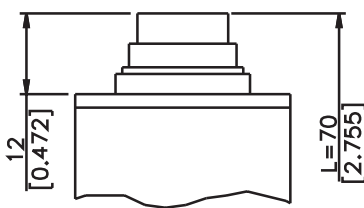

V - 6 pole connector

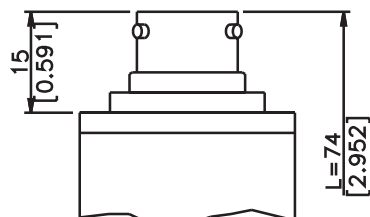

F - 4 pole connector

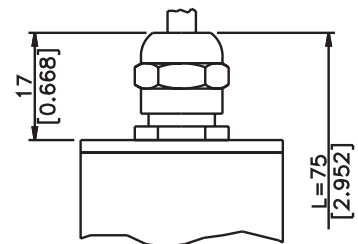

Z - 4 pole connector
M12x1

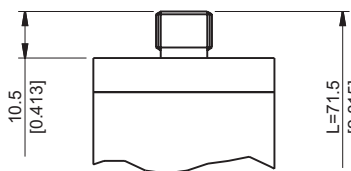

E - 4 pole connector
solenoid

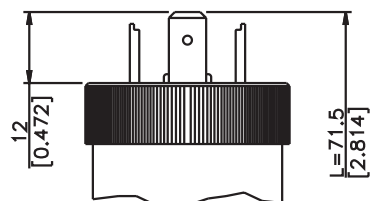

M - 4 pole connector
microsolenoid

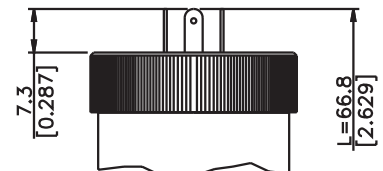

ELECTRICAL CONNECTION - Connectors

P - 7 pole connector

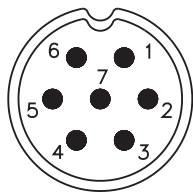

Male connector 09-127-09-07
Protection IP67

V - 6 pole connector

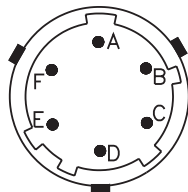

Male connector VPT02A10-6PT2
Protection IP66

F - 2-4 pole cable

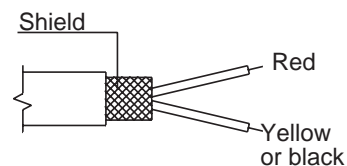

Shielded cable 2x0.25 - 2m. (output E)
Protection IP65

Z - 4-pole male connector M12 x 1

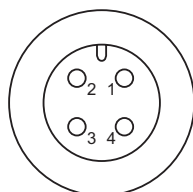

4 pole male connector 713 series
Protection IP67

E - 4 pole solenoid connector M - 4 pole microsolenoid connector

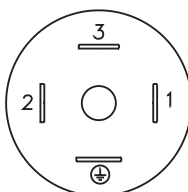

E - Solenoid DIN 43650A - ISO4400
Protection IP65
M - Microsolenoid DIN 43650C - ISO4400
Protection IP65

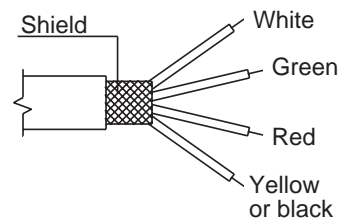

Shielded cable 4x0.25 - 1m
Protection IP65

ELECTRICAL CONNECTION - connection diagrams

VOLTAGE AMPLIFIED OUTPUT - mod. B/C/M/N/P/Q/R

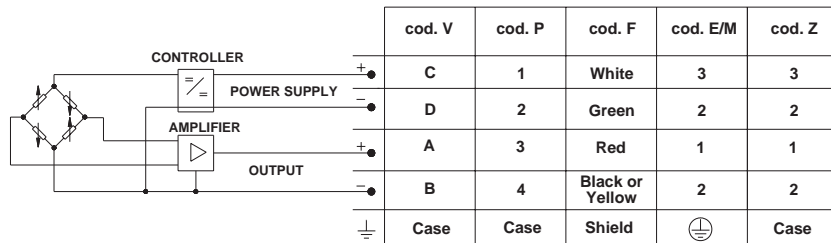

CURRENT AMPLIFIED OUTPUT - mod. E

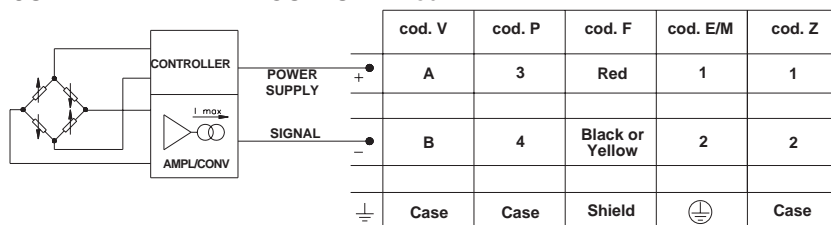

LOAD DIAGRAM (Output current)

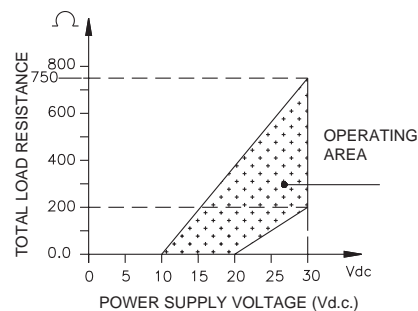

ACCESSORIES ON REQUEST

Connectors Plugs

Connection E

3 poles connector + ground DIN43650A ISO4400 **CON 006**
Prot. IP65

Connection Z

4 poles connector
Prot. IP67

CON 293

Connection M

3 poles connector + ground DIN43650C ISO4400 **CON 008**
Prot. IP65

Connection P

7 poles female cable connector Prot. IP67 **CON 321**

Connection V

6 poles female cable connector Prot. IP66 **CON 300**

EXTENSION CABLES

6-pin connector with 8m (25ft) cable

C08WLS

6-pin connector with 15m (50ft) cable

C15WLS

6-pin connector with 30m (100ft) cable

C30WLS

Other lengths

consult factory

Cable color code

Conn.	Wire
A	Red
B	Yellow/Black
C	White
D	Green
E	Blue
F	Orange

ORDERING INFORMATION

Pressure transmitter

TSA



OUTPUT SIGNAL	
Standard	
4 .. 20 mA	E
0 .. 10 Vdc	N
On request	
0.1 .. 5.1 Vdc	B
0.1 .. 10.1 Vdc	C
0 .. 5 Vdc	M
1 .. 5 Vdc	P
1 .. 10 Vdc	Q
1 .. 6 Vdc	R

PRESSURE CONNECTION	
Standard	
G 1/4 gas male	1
On request	
7/16-20 UNF-2A male (SAE 4 for AS4395-E)	2
G 1/2A (DIN 16288)	3
G 1/4 gas female	4
1/8-27 NPT female	5
1/4-18 NPT female	6
1/4-18 NPT male	7
M14 x 1.5 male	8
1/8-27 NPT male	9
G 1/4 male (DIN 3852-E)	E
M12 x 1.5 male	R
7/16-20 UNF-2A male (SAE 4 for J1926-2)	K
7/16-20 UNF-2A female (SAE 4)	F

ELECTRICAL CONNECTION	
4-pole connector solenoid	E
Shielded cable	F
Connector M12x1 4 pole	Z
4-pole connector microsolenoid	M
7 pole connector	P
6 pole connector	V

Mechanical and/or electrical characteristics differing from standard may be arranged on request.

RESPONSE TIME	
V	Fast (< 1 msec)

ACCURACY	
T	± 0.15%FSO typical

G	Gauge
A	Absolute

MEASUREMENT RANGE				
	bar		psi	
BV05	0..0.05		P01U	0..1
BV10	0..0.1		P2V5	0..2.5
BV25	0..0.25		P05U	0..5
BV50	0..0.5		P15U	0..15
B01U	0..1		P18U	11..18
B1V2	0.8..1.2		P03D	0..30
B02U	0..2		P05D	0..50
B2V5	0..2.5		P75U	0..75
B04U	0..4		P01C	0..100
B05U	0..5		P15D	0..150
B06U	0..6		P25D	0..250
B07U	0..7		P03C	0..300
B01D	0..10		P05C	0..500
B16U	0..16		P75D	0..750
B02D	0..20		P01M	0..1000
B25U	0..25			
B03D	0..30			
B04D	0..40			
B05D	0..50			
B06D	0..60			

■ = Range available also "Absolute"

B1V2 = Range available only "Absolute" (Barometric)

P18U = Range available only "Absolute" (Barometric)

Note: The measurement range B1V2 is for absolute pressure from 0.8 to 1.2 bar and is defined as "Barometric". The signal output is scaled from 800mbar (i.e. 4mA) to 1200mbar (i.e. 20mA).

CALIBRATION STANDARDS

Instruments manufactured by Gefran are calibrated against precision pressure calibration equipment which is traceable to International Standards.

Ex.: **TSA - N - 1 - P - B03D - G - T - V**

Pressure transmitter TSA with 0...10Vdc output signal, G 1/4 male pressure connection, 7 pole connector, pressure range 0...30 bar gauge, ± 0.15% FSO accuracy, 1msec response time.

GEFRAN spa reserves the right to make any kind of design or functional modification at any moment without prior notice

GEFRAN

GEFRAN spa
via Sebina, 74
25050 PROVAGLIO D'ISEO (BS) - ITALIA
tel. 0309888.1 - fax. 0309839063
Internet: <http://www.gefran.com>

cod. TSA - 03/06